



LCY130



Nominal Impedance 8 ohms
Nominal Power 150w
Max Power 400w
Sensitivity (2.83v/1m) 92dB
Weight 1.1Kg
Crossover Point > 2KHz

LCY-130 Ribbon (2.83V / 1M)

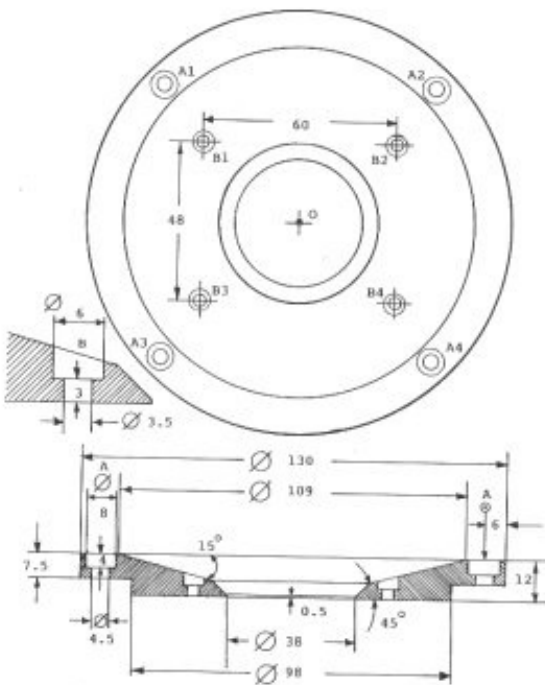
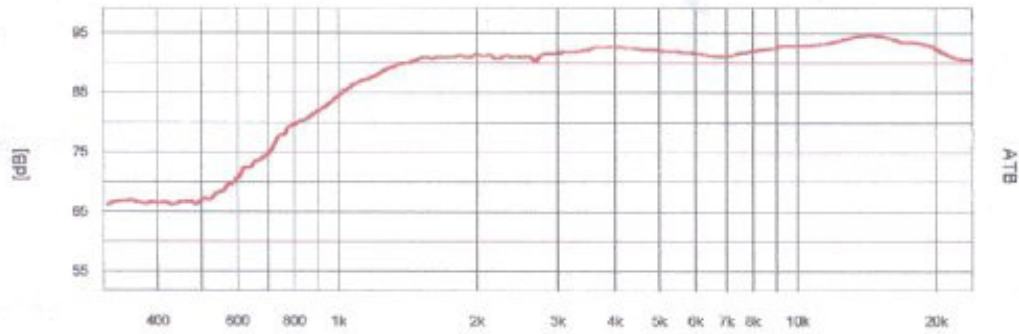

LCY Ribbon (2.83V / 0.25M)

